



# MONITORING DEVICE VEGA MT X CAN

## User Manual



REVISION NUMBER	FIRMWARE VERSION
13	0.10b rc41.18

# CONTENTS

INTRODUCTION .....	3
1 DESCRIPTION AND OPERATION .....	4
<b>Device description</b> .....	4
<b>Functionality</b> .....	4
<b>Marking</b> .....	5
<b>Device series</b> .....	6
2 SPECIFICATION.....	8
3 OPERATION BEGINNING .....	9
<b>Device appearance</b> .....	9
<b>Contacts description</b> .....	10
<b>Device indication</b> .....	11
<b>SIM installing</b> .....	12
<b>Mounting recomendations</b> .....	14
4 EXTERNAL EQUIPMENT CONNECTION.....	16
<b>Dallas temperature sensors</b> .....	16
<b>Authorized dallas keys</b> .....	18
<b>Fuel level sensors</b> .....	19
<b>Extension unit</b> .....	20
<b>Actuators</b> .....	20
<b>Inputs</b> .....	22
<b>Tachographs</b> .....	23
<b>BLE-sensors</b> .....	29
5 COMMUNICATION PROTOCOLS.....	30
6 MANAGING USING SMS-COMMANDS .....	31
7 STORAGE AND TRANSPORTATION REQUIREMENTS.....	35
8 CONTENT OF THE PACKAGE.....	36
<b>Int / Int v2</b> .....	36
<b>Ext / Ext v2 / LTE / LTE v2</b> .....	36
9 WARRANTY .....	37

## INTRODUCTION

This manual is designated for Vega MT X CAN series monitoring device (hereinafter – the device) manufactured by Vega-Absolute OOO and provides information on powering and activation procedure, control commands and functions of the device.

This manual is targeted at specialists which familiar with installation and repairing procedures rules for motor transport and had holding of professional knowledges in the field of electronic and electrical equipment of different vehicles.



**The device shall be installed and adjusted by qualified specialists to ensure proper operation of the device**

For successful using of the device you should learn monitoring system principle of operation in complex and understand the function of every its part.

Vega-Absolute OOO reserves the right to make changes to the manual related to the improvement of equipment and software, as well as to eliminate typos and inaccuracies, without prior notice.

# 1 DESCRIPTION AND OPERATION

## DEVICE DESCRIPTION

Vega MT X CAN device is designed for monitoring of vehicles by the using of GLONASS/GPS positioning systems including the determination of vehicle placement, speed, and motion direction as well as for transmitting of collected data through GSM.

Vega MT X uses the processor with a supporting up to three CAN-buses that allows to get a full information about vehicle.

The vehicle route is recorded as individual points in time (track). Along with the track, information is recorded coming into the device from internal and external sensors, as well as from an additional equipment. Non-volatile memory allows to store information about events and statuses of the device in the absence of power supply. Support of several servers allows to send information about vehicle status on the four servers simultaneously.

You can configure the device by SMS commands or through the “Configurator” application while the device connected with USB or by the air with TCP connection. Application also allows update a firmware and carry out the finest tuning such as operation scenarios for external equipment or CAN bus, features of fixing, recording, and transmitting of packets and many other. You can download application on the site in “Software” section and there is a Manual for work with “Configurator”. [Go to the program page.](#)

## FUNCTIONALITY

Vega MT X CAN provide the next functionality:

- ◉ Wialon IPS, Wialon Combine, EGTS, NDTP, VEGA protocols supporting
- ◉ Simultaneous operation with four servers through any of supported protocol
- ◉ Device activity can be programming by the “Scenarios” function (up to 25 scripts)
- ◉ Configuration through GPRS, USB, SMS
- ◉ Firmware updating through GPRS, USB
- ◉ Remotely configuring and monitoring of status through free engineer server
- ◉ Driver identification by the I-Button keys
- ◉ Temperature control at the engine compartment and the car salon with an external 1-Wire sensors

- Manage of actuators by the commands and by the events
- Built-in black box holding up to 100,000 entries
- SMS-notifications with a wide spectrum of set abilities
- GPS-odometer
- Geofences control with ability of SMS-notification and manage of actuators (up to 50 specified geofences)
- Trip counter
- Remotely diagnostic of the device status

## MARKING

Device marked with sticker that contain the next information:

- Device name (MT X CAN);
- Device version (for example, Int v2, LTE, Ext etc.);
- IMEI – individual number is used as device ID – is placed on sticker as number and QR-code;
- Release Date;
- Board revision (for example, rev.2);
- Certification mark, country of origin, trademark.



Sticker located in three places – on device case, in factory certificate and on the packing box.

## DEVICE SERIES

Version	Antennas	Bluetooth	GSM	ГНСС
Int	Internal	3.0 + BLE	Quectel MC60 4 band modem 850/900/1800/1900 MHz GPRS class 12 85.6 kbps Up/Down	Quectel MC60 ГЛОНАСС/GPS/Galileo/QZSS Sensitivity: -167 dBm (tracking) Hot start: 1 s / Cold start: 35 s Warm start: 4,5 s Channels: Acquisition: 99, Tracking: 33 Positioning accuracy: 2.5 m
Ext	External included			
LTE		no	Quectel EC21E LTE Cat 1 (10 Mbps down / 5 Mbps uplink) LTE-FDD: B1/B3/B5/B7/B8/B20 WCDMA: B1/B5/B8; GSM/GPRS/EDGE: 900/1800 MHz	U-blox EVA-M8M ГЛОНАСС/GPS/Galileo/QZSS/BeiDou Sensitivity: -164 dBm Hot start: 1 s / Cold start: 26 s Warm start: 3 s Channels: Acquisition: 72 Positioning accuracy: 2.5 m

<b>Int v2</b>	Internal	3.0 + BLE	SIM868E 4 band modem 850/900/1800/1900 MHz GPRS class 12 85.6kbps Up/Down	SIM868E ГЛОНАСС/GPS/Galileo/QZSS Sensitivity: -166 dBm Hot start: 1 s / Cold start: 29 s Warm start: 22 s Channels: Acquisition: 99, Tracking: 33 Positioning accuracy: 2.5 m
<b>Ext v2</b>	External included			
<b>LTE v2</b>		no	Simcom A7670E LTE Cat 1 (10 Mbps down / 5 Mbps uplink) LTE-FDD: B1/B3/B7/B8/B5/B20/B28 GSM/GPRS/EDGE: 900/1800 MHz	Quectel L76-L ГЛОНАСС/GPS/Galileo/QZSS Sensitivity: -167 dBm (tracking) Hot start: 1 s / Cold start: 35 s Warm start: 4,5 s Channels: Acquisition: 99, Tracking: 33 Positioning accuracy: 2.5 m

## 2 SPECIFICATION

Parameter	Value
Housing dimensions, mm	110 x 67 x 20
Ingress protection rating	IP53
External power, V	9...36
Consumption current, mA - in sleep mode - in active mode	Up to 5 40...300
Operating temperatures, °C	– 40...+85
Built-in battery	560 mAh
CUN-bus supported	3
RS-232	1
RS-485	1
UART	1
Lin/K-Line	1
Digital outputs	4
Multifunctional inputs	3
1-Wire	1
Ignition control input	1
Built-in accelerometer	Yes
GSM and GLONASS/GPS antenna	Internal or external <sup>1</sup>
SIM	2 SIM-cards or 1 SIM-chip and 1 SIM-card <sup>2</sup>
GSM-modem	4 diapason or LTE <sup>1</sup>
Micro-USB	Yes
Built-in black box	Up to 100 000 entries
Tamper sensor	2

<sup>1</sup> See “[Device series](#)” part

<sup>2</sup> In the MT X LTE v2 model, the SIM holder format is nanoSIM, in the rest of the models, microSIM is used



## 3 OPERATION BEGINNING

### DEVICE APPEARANCE

Vega MT X CAN is represented in black plastic case which has four screws and mounting eyelets. On the case there are LED indicators signed by pictograms, wire connector and USB. Depend on device version there might be connectors for external antennas GSM and GNSS.

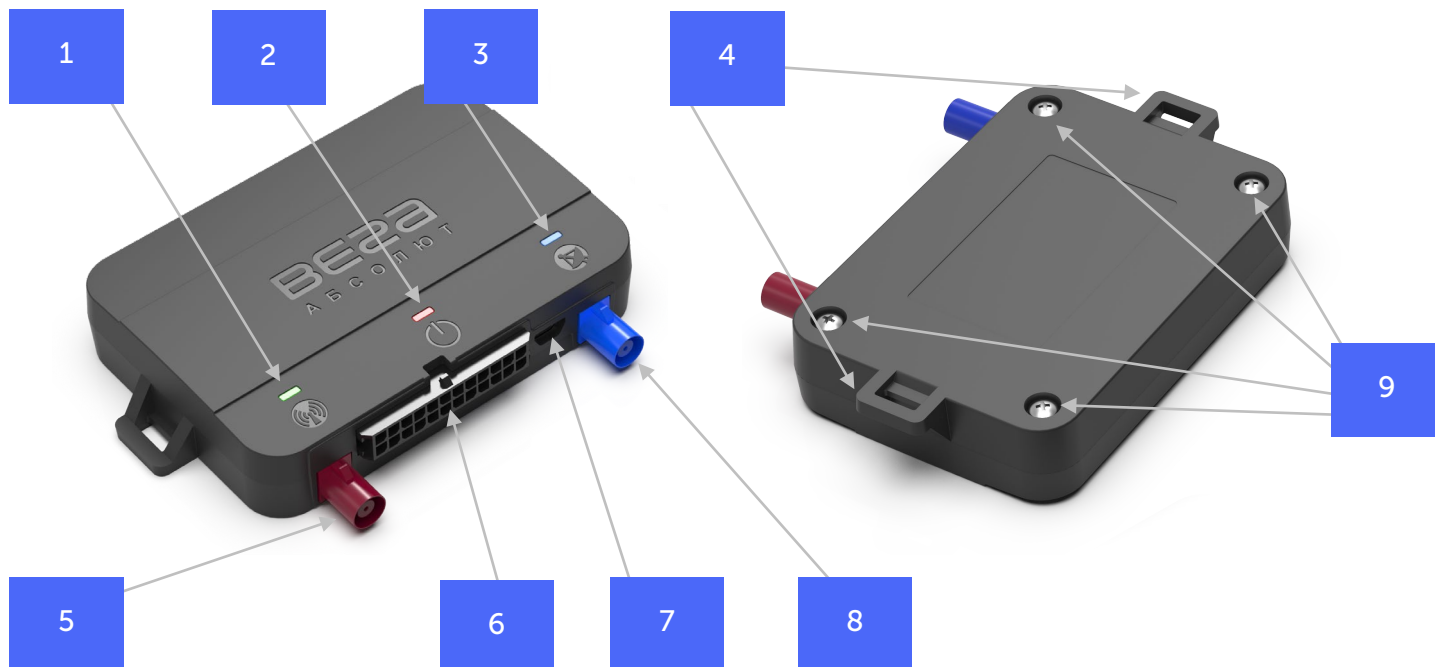

1 – LED indicator of GSM connection (green)

2 – LED indicator of power (red)

3 – LED indicator of GNSS module (blue)

4 – mounting eyelets

5 – connector for external GSM antenna

SIM slots are placed on the board inside the case (see part [«SIM installing»](#)).

6 – wire connector









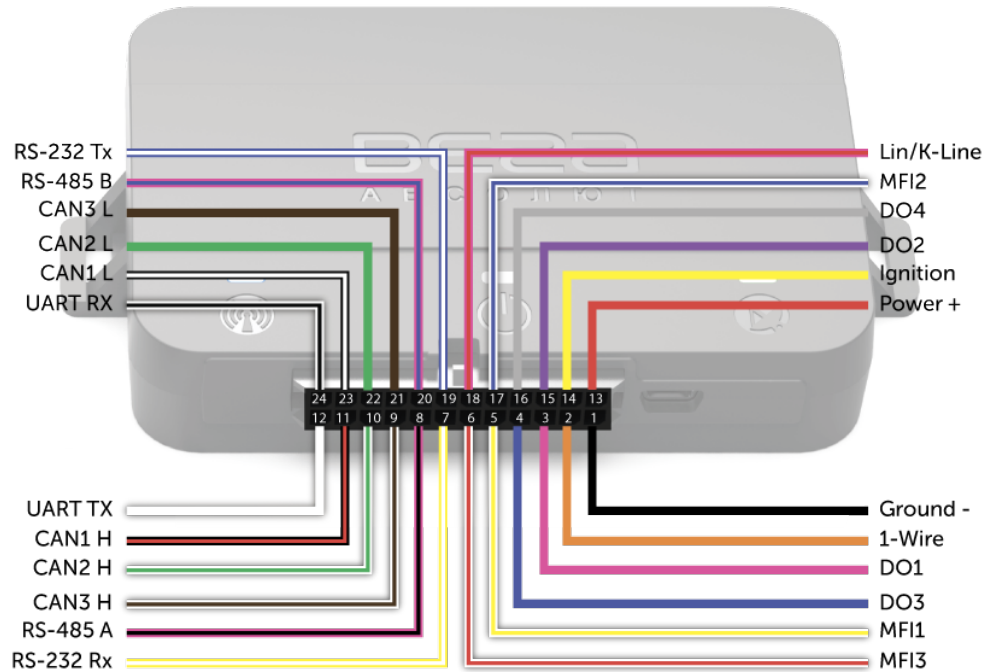



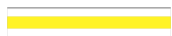

7 – USB connector







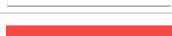

8 – connector for external GNSS antenna

9 – screw  $\varnothing 3 \times 10$  mm, cross 

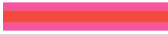
## CONTACTS DESCRIPTION









Contact	Wire color		Description
1	Black		Ground -
2	Orange		1-Wire
3	Pink		Digital output 1
4	Dark blue		Digital output 3
5	White + yellow		Multifunctional input 1
6	White + red		Multifunctional input 3
7	Yellow + white		RS-232 Rx
8	Pink + black		RS-485 A
9	White + brown		CAN3 High
10	White + green		CAN2 High
11	Black + red		CAN1 High
12	White		UART TX
13	Red		Power +
14	Yellow		Input of ignition control

15	Violet		Digital output 2
16	Grey		Digital output 4
17	White + dark blue		Multifunctional input 2
18	Pink + red		Lin/K-Line
19	Dark blue + white		RS-232 TX
20	Pink + dark blue		RS-485 B
21	Brown		CAN3 Low
22	Green		CAN2 Low
23	Black + white		CAN1 Low
24	White + black		UART RX

## DEVICE INDICATION

The device has three LED indicators. Blue indicator shows the navigation receiver status. Red indicator shows the presence of an external power. Green indicator shows GSM-connection status.

LED signal		Meaning
	Blue glowing	Navigation receiver in the mode of sputnik tracking. Location determined.
	Blue flashing one per second	Location determination in progress.
	Red glowing	External power supplying on.
	Red flashing	External power supplying off.
	Green not glowing	GSM-signal absent.
	Green glowing	The device is in range of a GSM network.
	Green flashing	GSM data exchange in progress.

## SIM INSTALLING

To use the Vega MT X CAN monitoring device, you need a micro-SIM<sup>3</sup> with support of SMS and GPRS functions. There must be cash on the account. PIN protection must be disabled.

The device supports the ability to use two SIM cards. In this case, one of them will perform the reserve function, and will be used only if it is not possible to send data from the first main SIM.

The devices have their own algorithm for SIM-card switching from main to reserve and back:

- 1) The device cannot join to the network for the 5 minutes while it operates with main or reserve SIM-card;
- 2) If 16 unsuccessful attempts were made to establish a TCP connection to each server (not disabled in the settings);
- 3) If a TCP connection is established, but there is no data at the application level from the servers for the 5 minutes.

To install the SIM, you must remove the top cover of the device and de-energize the board by carefully disconnecting the battery. Then insert the SIM into the holder, connect the battery and assemble the device.



**To avoid damage and malfunction, it is recommended to perform all manipulations with the board when it is de-energized**

The location of the primary and secondary SIM slots is shown in the figure below, the primary slot is highlighted in red.

---

<sup>3</sup> In the MT X LTE v2 model, the SIM holder format is nanoSIM, in the rest of the models, microSIM is used

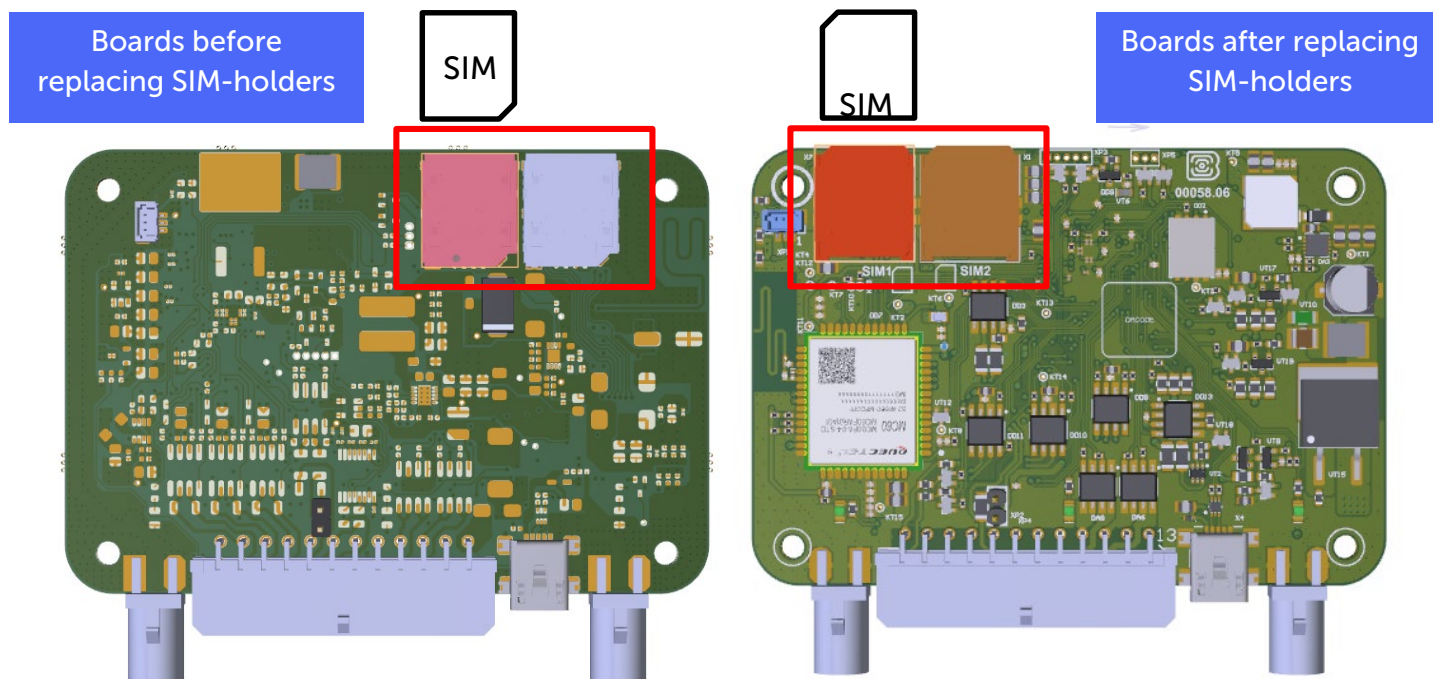

The location of the SIM slots may differ depending on the board version, and the SIM card may be installed in different way

Boards before replacing SIM-holders	Boards after replacing SIM-holders
MT X Ext – revision <sup>4</sup> 3 and lower MT X Int – revision 1 MT X LTE – revision 1	MT X Ext – revision 4 and higher MT X Int – revision 2 and higher MT X LTE – revision 2 and higher Int v2 Ext v2

<sup>4</sup> The board revision can be found through the "Configurator" application or on the device sticker (see part "[Marking](#)")

## MOUNTING RECOMENDATIONS

First, you need to make connection settings, after which you can configure and change other parameters at any time remotely as needed. Connection settings are:

- ◉ monitoring servers' settings (protocol, IP-address and port);
- ◉ network settings (SIM access point settings);
- ◉ settings for transmitting readings (information that will be transmitted to the server).

Initial configuration is carried out through USB-port with Configurator application. For this you should follow the next steps:

1. Install the main SIM-card (see part "[SIM Installing](#)").
2. Connect the device to a PC through USB-port located on the front panel.
3. Run the Configurator application on the PC, press "Connect" button and choose the connection method like "Connect through USB".
4. On the left menu choose "Settings".
5. Make connection settings.



**Pay attention to the settings for connecting to the engineering server using the VEGA protocol. These parameters will be used when connecting to the device remotely through the Configurator program**

6. After setting connection parameters press the "Save" button.
7. Disconnect USB-cable.
8. Try test connection through the air for checkup of the connection parameters.
9. If the connection is successfully done, then the device is ready for installing on a vehicle.

For mounting you will need:

- ◉ wires and fuse which are included in a package;
- ◉ wire stripper;
- ◉ laptop.

Step by step mounting is as follows:

1. De-energizing the connected equipment and the vehicle's on-board power.
2. Connection of external power wires according to the scheme through a fuse.

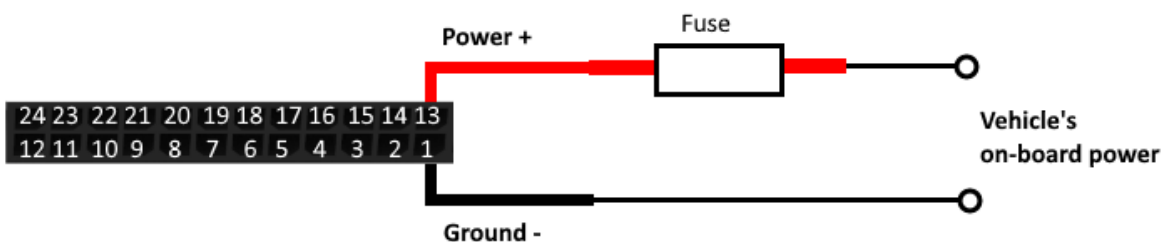

3. Power ON.
4. Connection of an external equipment, sensors, and configuration of them (see part "[External equipment connection](#)").
5. Device configuration, CAN bus operation if it is needed.
6. By the laptop you can make sure that the device is successfully configured and sends the correct data.
7. Mounting of the device with zip ties.
8. Placement of external antennas if necessary.

General recommendations for the placement of antennas boil down to two rules: **avoid covering the GSM antenna with metal parts** of the vehicle and, if possible, **provide a line of sight to satellites (i.e., open skies)** for the GNSS antenna.

## 4 EXTERNAL EQUIPMENT CONNECTION

### DALLAS TEMPERATURE SENSORS

Vega MT X CAN monitoring device allows to connect is up to ten Dallas temperature sensors through 1-Wire interface. Connection scheme is on the picture below. If connected temperature sensor has three contacts instead of two then you should close "Power" with "Ground".

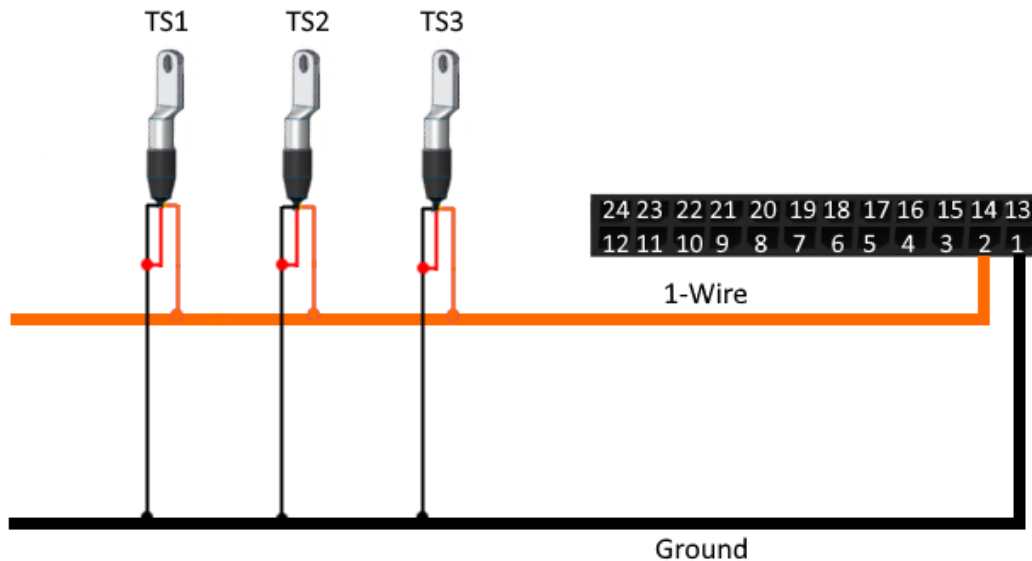

For the device to recognize the connection of a new sensor, it is necessary to connect to the device through the "Configurator" program, go to the "Settings" menu -> "Inputs/outputs" tab and select the "Dallas temperature sensors" setting item.

To distinguish sensors after connection, it is recommended to connect them one at a time. Having connected the first sensor according to the diagram above, click the "Add sensors" button. An information window will appear.

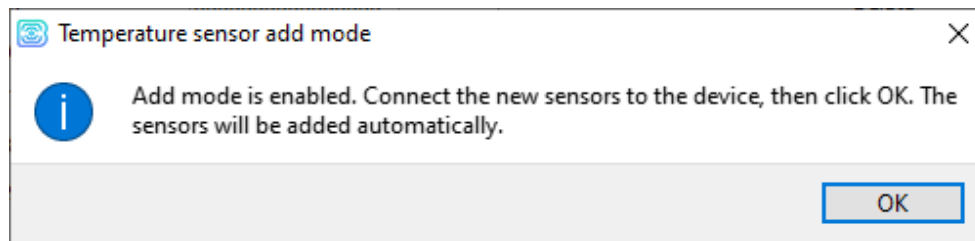



Click "OK" - the sensor number will be added to the free field. After that you can connect the next sensor in the same way.

You can also connect several sensors in turn, while the add window is open, in this case, after clicking the "OK" button, the sensors will be put into free fields in the order in which they were connected.

After connecting all temperature sensors, you must click the "Save" button to put information about sensors into device memory.

## AUTHORIZED DALLAS KEYS

Vega MT X CAN monitoring device allows you to connect an I-Button authorized key reader to a 1-Wire pin. The connection scheme is shown in the figure below. The number of authorized keys can reach ten. To add a key, you need to connect to the device through the "Configurator" program and go to the "Settings" menu -> "Security" tab.

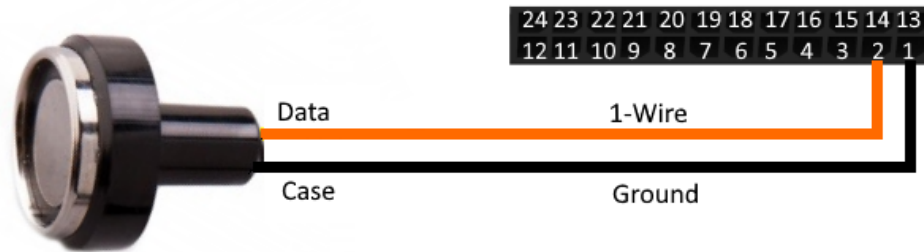

In the "Security" tab, expand the "Authorized Dallas keys" settings item and click the "Add Dallas keys" button. A dialog box will appear.

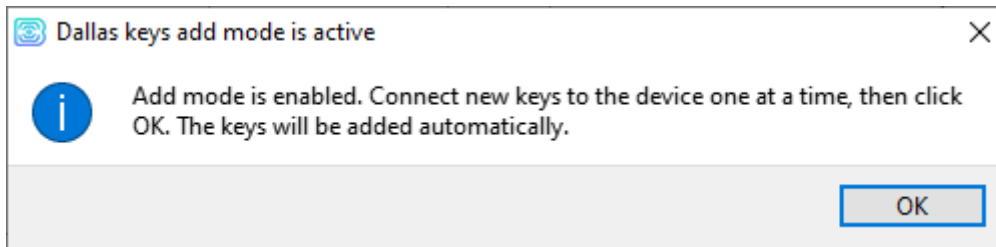

Attach the key to the reader as during authorization - the device will remember the key number - and click "OK". The key number appears in the free field. If several keys are added at the same time, it is allowed to attach them to the reader in turn, while the add window is open, and only then click "OK" - the numbers of all keys will be added to the free fields in the order in which they were applied to the reader.

Click the "Save" button to put information about keys into device memory.

## FUEL LEVEL SENSORS

The monitoring device allows you to connect fuel level sensors via the RS-485 bus and operates with them using the LLS protocol. To do this, you need to connect to the device through the "Configurator" program and go to the "Settings" menu -> "Inputs/Outputs" tab. For each connected fuel level sensor, it is necessary to select "Sensor Type" - RS-485 or RS-232 and specify the sensor address on the bus in the "Bus Address" field. The specified address must match the address specified when the sensor programming (see instructions for the used sensor).

Up to four fuel level sensors can be connected simultaneously.

Click the "Save" button to put information about sensors into device memory.

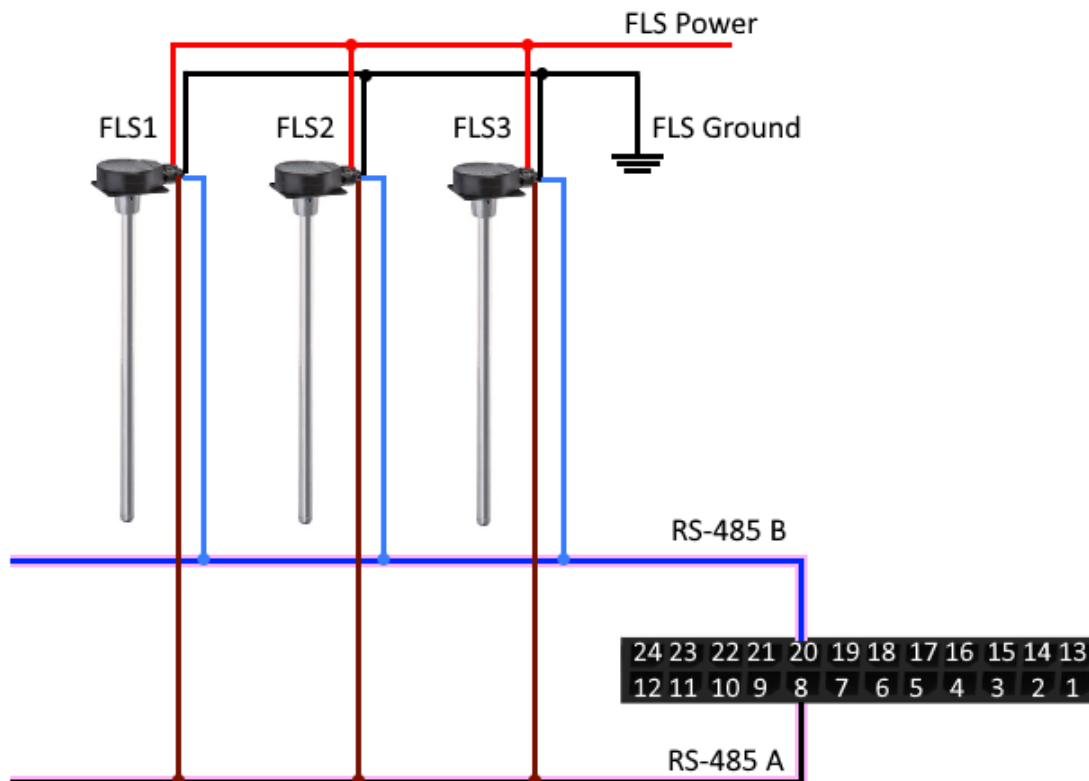

## EXTENSION UNIT

The Vega MT X CAN monitoring device allows you to connect the Vega BR-1 expansion unit via the RS-485 or RS-232 interface. Vega BR-1 has 15 multifunction inputs and 15 digital outputs.

To configure the inputs, you must connect to the device through the “Configurator” program, go to the “Settings” menu -> “Inputs/Outputs” tab and select the “Input/output extension unit”. Next, you need to select the connection interface - RS-485 or RS-232. After that, you can configure [multifunctional inputs](#) in accordance with the desired tasks.

To configure the outputs, it is necessary to connect to the device through the “Configurator” program, go to the “State” menu -> “Input/output expansion unit” tab. At the very bottom of the I/O list of the expansion unit are the digital output controls - the “On” and “Off” buttons.

## ACTUATORS

Actuators are connected to the device via digital outputs 1, 2, 3 and 4, which are of the type “Open collector”.

So, for example, you can connect a relay for blocking the engine/petrol pump/ignition, etc. After connecting the relay according to the scheme, you can send commands to the device to block or unblock the relay (see the section “[SMS commands](#)”, command `setout`).

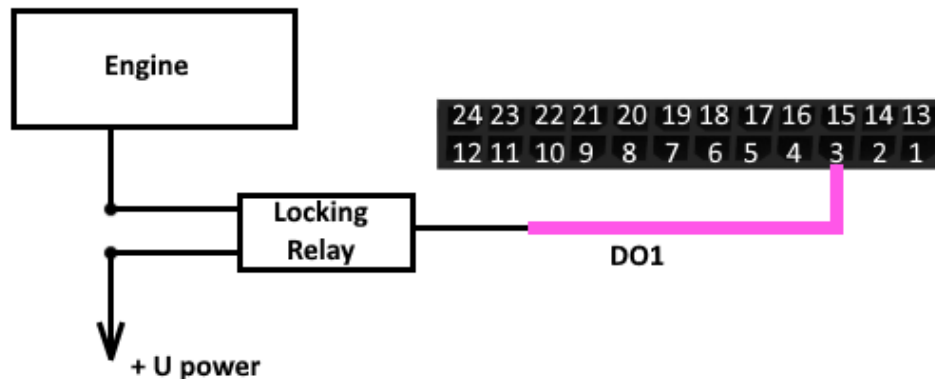



Permissible load on each digital output 0.5 A

To increase the load on the outputs of the device, you must use an external relay. The relay connection diagram is shown below.

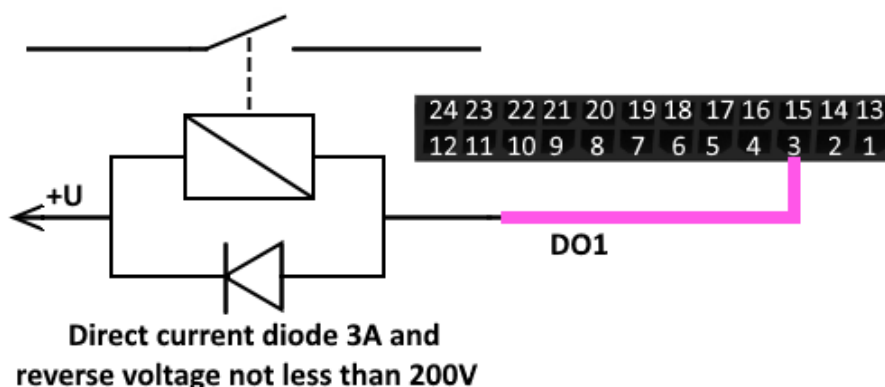

By default, after a device reboot, the state of the digital output is reset to 0, that is, "off". In the settings, it is possible to save the state of the device output and digital outputs of the connected [extension unit](#).

To do this, you need to connect to the device through the "Configurator" program, go to the "Settings" menu -> "Inputs/Outputs" tab and select the "Restoring output states after reboot". Opposite the desired output, select "restore" in the drop-down menu. Then, after a reboot, this digital output will be restored to the state that was written to the non-volatile memory of the device before the reboot.



Writing of statuses into non-volatile memory carried out at every 30 seconds

## INPUTS

Vega MT X CAN monitoring device has three multifunctional inputs that can operate in four modes:

- Analog;
- Digital;
- Frequency;
- Pulse.

In analog mode, the input voltage is measured. Such an input can be used for sensors whose readings vary in a certain range.



Range of measured voltages of the analog input is 0...36 V

In digital mode, the input signal level (0 or 1) is measured. Such an input can be used for logic sensors, the readings of which are determined by two states (on/off).

In frequency mode, the frequency of the pulse signal is measured. Such an input, for example, is convenient to use for a car tachometer.

In pulse mode, the number of pulses at the input is counted. Such an input can be used for flow rate sensors, for example, fuel consumption.

In the settings of multifunctional inputs in the "Configurator" program, in addition to selecting a mode for each input, there is a parameter called "Active Level". It can take the value "low" and "high" and characterizes the magnitude and direction of the input tightening.

Input type	Low active level	High active level
<b>Ext (board revision<sup>5</sup> is lower than 3-d)</b>		
Analog	Pull-down to the ground 22 kOhm	Pull-down to the ground 22 kOhm
Digital	Pull-up to external power 44 kOhm	Pull-down to the ground 22 kOhm
Pulse	Pull-up to external power 44 kOhm	Pull-down to the ground 22 kOhm
Frequency	Pull-up to external power 44 kOhm	Pull-down to the ground 22 kOhm

<sup>5</sup> The board revision can be found through the "Configurator" application in the menu State-> System-> Board revision

Int, Ext (board revision is higher than 4-th), LTE, Int v2, Ext v2, LTE v2		
Analog	Pull-down to the ground 240 kOhm	Pull-down to the ground 240 kOhm
Digital	Pull-up to external power 44 kOhm	Pull-down to the ground 240 kOhm
Pulse	Pull-up to external power 44 kOhm	Pull-down to the ground 240 kOhm
Frequency	Pull-up to external power 44 kOhm	Pull-down to the ground 240 kOhm



**Pull-up to external power cannot be carried out while battery powered device**



**When the device of the MT X Ext model (board revision is 3 and lower) is restarted, the multifunction input is pulled to external power, and in the rest of models when the device is restarted, the input is pulled to the ground**

## TACHOGRAPHS

Vega MT X monitoring devices support the following tachograph models:

- ◉ Mercury TA-001,
- ◉ Shtrih - Taxo RUS,
- ◉ Atol Drive 5,
- ◉ Continental VDO DTTCO 3283/1381.



**DDD files are uploaded from tachographs only to the 1st server via WIPS and WCOMBINE protocols**

All models support the WIPS/WCOMBINE commands listed in the protocol (see the protocols description [www.fmsvega.ru](http://www.fmsvega.ru)).

Useful applications for working with the tachograph are [Tacho Manager](#) - an application for storing and loading DDD files manually from a computer and [Tacho View](#) - an application for visual analysis of driver activity.

The data transmitted by each tachograph is listed in the table.

Data	Mercury TA-001, Atol Drive 5	Shtrih - Taxo RUS	Continental VDO DTCO 3283/1381
Tachograph commands (download data from card 1, download data from card 2)	+	+	+ download is available only from slot 1
Status and type of tachograph	+	+	+ updated only when trying to get DDD file
Tachograph date and time	+	+	-
Vehicle registration number	+	+	-
Vehicle VIN number	+	+	-
Odometer readings, 0.1 km	+	+	-
Tachograph Status Flags (Ignition, Backlight, Ground Off, Ferry/Train)	+	+	-
Card X state	+	-	- available via CAN sensors functionality, TCO01, PGN FE6C
Card type in slot X	+	+	-
Activity, card X	+	+	- available via CAN sensors functionality, TCO01, PGN FE6C
Card number in slot X	+	+	-
Driver X, identification line 1	+	+	-
Driver X, identification line 2	+	+	-
Driver X, time in the current mode	-	+	-
Driver X, total driving time per day	-	+	-
Driver X, continuous driving time	-	+	-
DDD file upload status to device	+	+	+



X = 1, 2.

The connection of each type of tachograph has its own features, we will consider their connection separately.

**Mercury TA-001** connects through RS-485 interface. You should be sure that the firmware version is not lower than V104\_0210\_norm. Current firmware versions and update instructions are by the [link](#). In the tachograph settings for the RS-485 interface, the **ScoutNet** protocol must be selected.

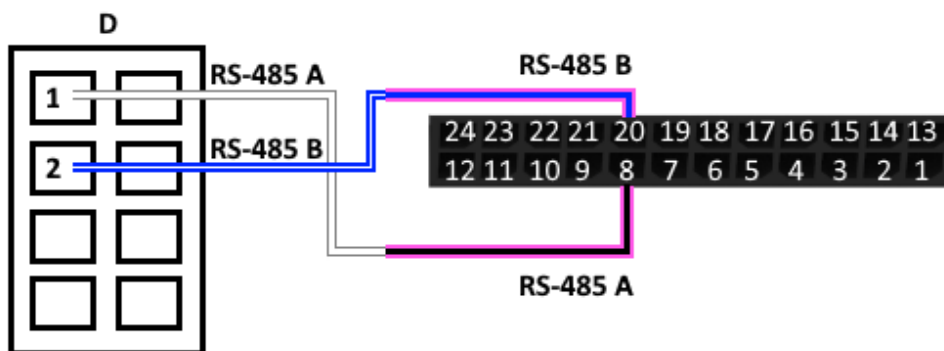

Shtrih - Taxo RUS connects through RS-485 interface. In the tachograph settings for the RS-485 interface, the Shtrih-Taxo protocol must be selected.

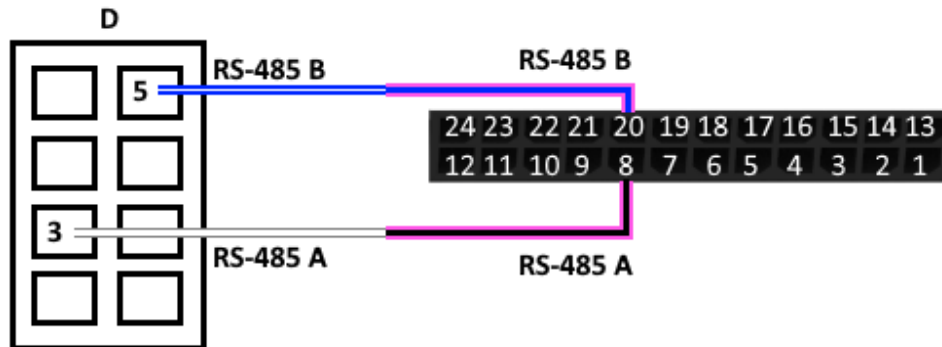
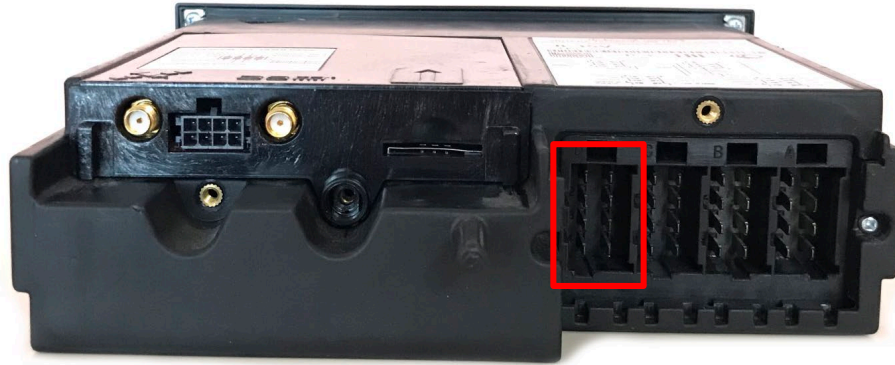

Atol Drive 5 connects through UART interface or through UART <-> RS-232 converter. In the tachograph settings in the part «Penal – Penal protocol», the **ScoutNet** protocol must be selected. Please note that this tachograph model goes into sleep mode if not used for 25 seconds, and after 7 minutes falls asleep even deeper.

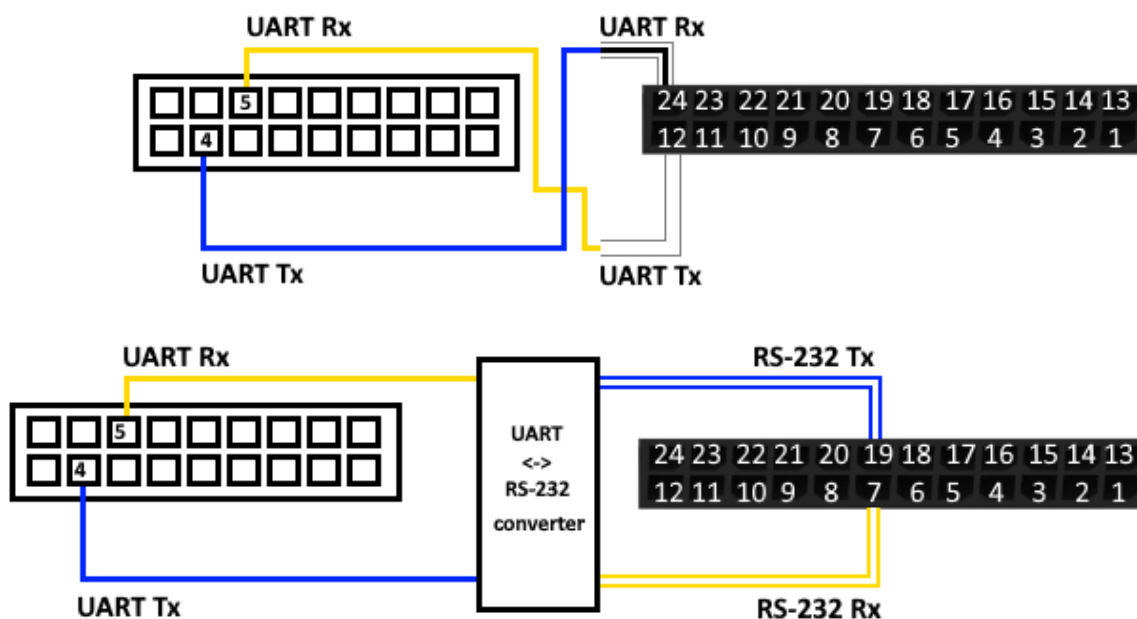

Continental VDO DTCO 3283/1381 connects through RS-232 interface located on the front of tachograph. For reading the data about cards and tachograph, it is necessary to connect the vehicle CAN-bus to the tachograph and monitoring device. CAN-bus connecting is option.



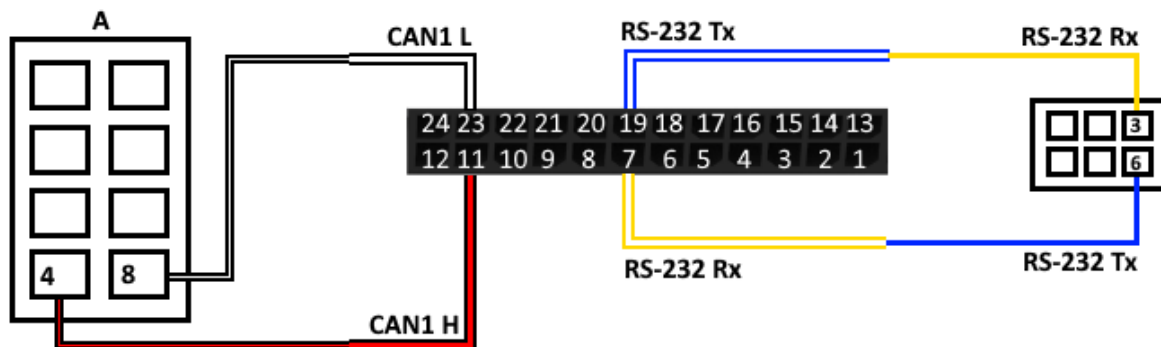

From the side of the monitoring device, you should also configure the interface for working with the tachograph. To do that you need to connect to the device through the "Configurator" program and go to the "Settings" menu -> "Tachograph" tab.

## BLE-SENSORS



**Operation with BLE sensors is supported both of Int v2 and Ext v2 models, as well as devices of Int and Ext models with a firmware version of at least 0.10b rc41.1 and a firmware version of the GSM modem MC60E ... (after the number 60, there must be a letter E). It is also worth considering that Bluetooth does not work without a SIM card and whenever if the GSM modem is disconnected**

Up to 10 sensors can be connected. For this it is necessary to connect to the device through the "Configurator" program, go to the "State" menu -> "BLE Sensors" tab -> "Scanner" tab. There you can make Bluetooth scanning and create sensor from the list of discovered sensors as a result of scanning by context menu or button "Create BLE-sensor".

### Supported types of BLE-sensors.

- ◉ BLE beacon – MAC binding tag;
- ◉ Neomatika ADM31/ADM35 – sensor of temperature, humidity, ambient light level;
- ◉ Neomatika ADM32 – angle sensor;
- ◉ Escort TD-BLE – fuel level sensor;
- ◉ Escort TT-BLE – temperature sensor;
- ◉ Escort TL-BLE – sensor of temperature, ambient light level;
- ◉ Escort DU-BLE – angle sensor;
- ◉ Escort TH-BLE – sensor of temperature, humidity, ambient light level, pressure.

## 5 COMMUNICATION PROTOCOLS

The Vega MT X CAN monitoring device supports several protocols: EGTS, WIALON IPS, WIALON Combine, VEGA, NDTP. The current protocol description is contained in a separate document, which can be found on the website [fmsvega.ru](https://fmsvega.ru).

## 6 MANAGING USING SMS-COMMANDS

Some settings of the Vega MT X CAN monitoring device can be managed remotely via SMS commands. General command format is @PIN:command, where PIN is a four numbers PIN of the device (See "Security" part). There are also two information commands, in response to which an SMS message with information about the device settings.

Command	Format	Example
<b>nosleep</b> – not switch to the sleep mode	@PIN:nosleep	@5555:nosleep ----- PIN – 5555
<b>reboot</b> – device reboot	@PIN:reboot	@3333:reboot ----- PIN – 3333
<b>rebootgnss</b> – GNSS transmitter reboot	@PIN:rebootgnss	@7667:rebootgnss ----- PIN – 7667
<b>tofactory</b> - factory reset	@PIN:tofactory	@1234:tofactory ----- PIN – 1234
<b>bboxclear</b> – clear black box	@PIN:bboxclear	@1234:bboxclear ----- PIN - 1234
<b>setout</b> – set the output state	@PIN:setoutY=Z ----- Y – output number Z – state (0 or 1)	@4321:setout2=1 ----- PIN – 4321 Output number – 2 State – 1
<b>setextout</b> – set the output state of extension unit	@PIN:setextoutY=Z ----- Y – output number of extension unit Z – state (0 or 1)	@4444:setextout8=0 ----- PIN – 4444 Output number of extension unit – 8 State – 0

<p><b>server</b> – set the server address</p>	<p>@PIN:serverY:addr:port&amp;protocol&amp;period&amp;terminal_addr</p> <p>-----  <b>Y</b> – server number  <b>addr</b> – server address  <b>port</b> – server port  <b>protocol</b> – protocol type:                  off                  vega – engineering server                  egts – EGTS server                  egts_l1 – EGTS Light 1                  egts_l2 – EGTS Light 2                  wcombine – Wialon Combine server                  wips – Wialon IPS server                  ndtp – NDTP server</p> <p><b>period</b> – communication period with server  <b>terminal_addr</b> – device address for NDTP or device ID for EGTS protocol</p>	<p>@2222:server3:193.193.165.165:20332&amp;wips&amp;0&amp;90008</p> <p>-----                  PIN – 2222                  Server number – 3                  Server address – 193.193.165.165                  Server port – 20332                  Exchange protocol – Wialon IPS                  Communication period – 0 (constantly in touch)                  NDTP address or EGTS device ID – 90008</p>
<p><b>setapn</b> – set APN</p>	<p>@PIN:setapn:apn&amp;user&amp;pass</p> <p>-----  <b>apn</b> – APN  <b>user</b> – username  <b>pass</b> – password</p>	<p>@1234:setapn:internet.beeline.ru&amp;beeline&amp;beeline</p> <p>-----                  PIN – 1234                  APN – internet.beeline.ru                  Username – beeline                  Password – beeline</p>
<p><b>info?</b> – current device state request</p>	<p>@PIN:info?</p>	<p>@1234:info?</p> <p>-----                  PIN – 1234</p>
<p><b>server?</b> - request monitoring server settings</p>	<p>@PIN:server?</p>	<p>@4444:server?</p> <p>-----                  PIN – 4444</p>
<p><b>runcanscript</b> – run CAN script number X</p>	<p>@PIN:runcanscriptX</p> <p><b>X</b> – CAN number that is needed to run</p>	<p>@4444:runcanscript3</p> <p>-----                  PIN – 4444                  CAN script number 3</p>



<b>t:unixtime</b> – set lifetime for the command	@PIN:XXXX/t:unixtime <b>XXXX</b> – command for which is needed to set a lifetime <b>unixtime</b> – time in UTC when the command will not execute even the SMS with it just comes. For example, we send the command for device rebooting at the 14.00 and set lifetime for that command until 14.10. So if the device receives the command from 14.00 to 14.10 the command will execute as usual, but if the SMS will delayed, will not be delivered immediately etc., and the device receives the command at the 14.15 the command will not execute because lifetime is up. After the time has passed, the message "Execution time has expired" will come	@4444: reboot/t: 1577196600 ----- PIN – 4444 Command – device reboot Lifetime of the command is until 14:10:00 24.12.2019
<b>changesim</b> – change current SIM	@PIN:changesim	@4444:changesim ----- PIN – 4444
<b>changesim1</b> – change SIM to the first	@PIN:changesim1	@4444:changesim1 ----- PIN – 4444
<b>changesim2</b> – change SIM to the second	@PIN:changesim2 Answer examples: <i>changesim:2 ok</i> – command successfully done; <i>changesim:2 err, already in use</i> – SIM2 already used.	@4444:changesim2 ----- PIN – 4444

When requesting the current state of the block, a message arrives with the following contents:

Vega MT X CAN v3.10 0.4b – device name and firmware version

imei: 355217043382910 – device IMEI number

lat: 55.1173, lon: 37,9475, - device coordinates (latitude and longitude)

sat inview: 22, - number of visible satellites

sat inuse: 14, - number of satellites used

valid: 1 – validity of certain coordinates (0 – no, 1 – yes)

ign: 0, - ignition (0 – no, 1 – yes)

acc: 4.1, ext: 12.1, - built-in battery and vehicle voltage

temp: 19,5, - environment temperature

move: 0 – moving (0 – no, 1 – yes)

black box: 0, 4, 0, 0 – the number of messages in black boxes in order in the 1st, 2nd, 3rd and 4th.

When you request monitoring server settings, a message appears with the following contents:

server1:

193.193.165.144:20333&wips&0&0

server2:

46.183.183.4:16122&egts&15&43382912

server3:

193.193.154.154:20453&off&0&0

server4:

37.194.197.213:5604&vega&0&0

Here in order are indicated - server address: port & protocol (if enabled) or off (if data exchange with this server is turned off) & communication period in minutes & device address for NDTP or device ID for EGTS protocol.



If you enter an incorrect PIN, the device does not respond to the sender

## 7 STORAGE AND TRANSPORTATION REQUIREMENTS

Vega MT X CAN devices shall be stored in the original packaging in heated room at temperatures +5 °C to +40 °C and relative humidity less than 85%.

The device shall be transported in covered freight compartments of all types at any distance at temperatures -40 °C to +85 °C. After transporting the devices at low temperatures, it is recommended to hold them at room temperature for 24 hours before starting operation.

## 8 CONTENT OF THE PACKAGE

Content of the package of the Vega MT X CAN device depend on the model. You can identify the device model by the sticker in the factory certificate (see part "[Marking](#)").

### INT / INT V2

Vega MT X CAN monitoring device (Int / Int v2) – 1 pc.

Wire connector – 1 pc.

Fuse – 1 pc.

Factory certificate – 1 pc.

### EXT / EXT V2 / LTE / LTE V2

Vega MT X CAN monitoring device (Ext / Ext v2 / LTE / LTE v2) – 1 pc.

Wire connector – 1 pc.

Fuse – 1 pc.

Factory certificate – 1 pc.

GSM antenna – 1 pc.

GLONASS/GPS antenna – 1 pc.

## 9 WARRANTY

The manufacturer guarantees that the product complies with the current technical documentation, subject to the storage, transportation and operation conditions specified in the "User Manual".

The warranty period is 36 months.

The warranty for the battery is provided separately and is 6 months.

The warranty period of operation is calculated from the date of sale marked in the product factory certificate, and from the release date when such a mark is absent. During the warranty period, the manufacturer is obliged to provide repair services or replace a failed device or its components.

The manufacturer does not bear warranty obligations in the event of a product failure if:

- ◉ the product does not have a factory certificate;
- ◉ the factory certificate does not have an TCD stamp and / or there is no sticker with information about the device;
  - ◉ the serial number (DevEUI, EMEI) printed on the product differs from the serial number (DevEUI, EMEI) specified in the factory certificate;
  - ◉ the product has been subject to alterations in the design and / or software which are not provided for in the operational documentation;
  - ◉ the product has mechanical, electrical and / or other damage and defects arising from violation of the conditions of transportation, storage and operation;
  - ◉ the product has traces of repair outside the manufacturer's service center;
  - ◉ the components of the product have internal damage caused by the ingress of foreign objects / liquids and / or natural disasters (flood, fire, etc.).

In the event of a warranty claim, contact the service center:

113/1, Kirova Str., Novosibirsk, 630008, Russia.

Tel.: +7 (383) 206-41-35.

Document Information	
Title	Monitoring Device Vega MT X CAN
Document Type	Manual - Translation from Russian
Document Number	B01-MT10-01
Revision and date	13 of 27.09.2021

This document complies to the next devices:

Series Name	Device Name
Vega MT X	Vega MT X CAN Int
	Vega MT X CAN Ext
	Vega MT X CAN LTE
	Vega MT X CAN Int v2
	Vega MT X CAN Ext v2
	Vega MT X CAN LTE v2
	Vega MT X CAN LTE v2

#### Revision History

Revision	Date	Name	Comments
01	22.07.2019	KEV	Document release date
02	10.12.2019	KEV	New functions in Configurator description, new <a href="#">CAN-script launch command</a> , SIM-cards <a href="#">auto switching</a>
03	07.04.2020	KEV	Part <a href="#">11 File server</a> is added, new settings for the <a href="#">CAN-sensors</a>
04	14.05.2020	KEV	<a href="#">SMS-commands</a> for SIM changing are added
05	04.06.2020	KEV	The <a href="#">functionality</a> and <a href="#">settings</a> description of BLE sensors is added
06	25.08.2020	KEV	Minor changes in <a href="#">Configurator's</a> parts

07	02.10.2020	KEV	Description of connecting supported <a href="#">tachographs</a> , other edits
08	09.11.2020	KEV	There is a new server type for <a href="#">SMS</a> command: Wialon Combine, there are the new <a href="#">SIM</a> -holders in the new board revisions
09	04.12.2020	KEV	There is an alarm about <a href="#">SIM</a> -card installing in the unpowered device
10	29.03.2021	KEV	There are new server types for <a href="#">SMS</a> command: EGTS Light1 and Light2
11	11.06.2021	KEV	There is an <a href="#">information</a> about new versions of the device
12	11.08.2021	KEV	Scheduled revision of the documentation, the part "Configurator" has been removed, now there is a separate manual for the program, new parts
13	27.09.2021	KEV	New <a href="#">SMS command</a> is rebootgnss for GNSS rebooting



[vega-absolute.ru](http://vega-absolute.ru)

User Manual © ООО Vega-Absolute, 2019-2021